

EPOS

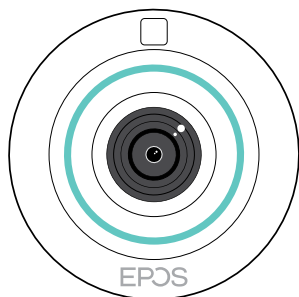

EXPAND Vision 5

Video collaboration bar

User Guide

Model: DSWBT1

Contents

Welcome	2
Package contents	3
Vision 5 at a glance.....	4
Video collaboration bar at a glance.....	4
LEDs at a glance.....	5
Placing / mounting Vision 5	6
Installation options.....	6
A Mounting the product on a wall.....	7
B Placing the product on a desk.....	8
Connecting / preparing devices	9
Taking off / Putting on the cover.....	9
Connection possibilities.....	10
1 Connecting a screen.....	12
2 Connecting to a network.....	13
3 Connecting to the power supply.....	14
4 Connecting a control.....	15
Using EXPAND Vision 5 in USB-mode (BYOD).....	17
Connecting a laptop for content sharing.....	18
Connecting other accessories	19
How to use – the basics.....	20
Adjusting the camera.....	20
Changing the volume	23
Muting / unmuting the microphone.....	23
Joining meetings / calls.....	24
Sharing content in a meeting.....	25
Good to know.....	27
Using an optional Kensington® lock	27
Standby mode & waking up.....	28
Using the privacy buttons.....	30
Changing Vision 5 settings.....	31
Maintaining & updating products.....	32
Cleaning the products.....	32
Updating the firmware.....	32
If a problem occurs.....	33

Welcome

Enhanced Meeting Experience

Take video conferencing to a new level with EXPAND Vision 5 for small and medium sized meeting rooms.

A powerful all-in-one video bar with outstanding audio performance and razor-sharp video thanks to two integrated speakers and four microphones.

Easy to set up with flexible mounting options, cable management and electro-mechanical pan/tilt for optimal installation.

Leverage the built-in compute to run UC applications natively on the device for a seamless user experience.

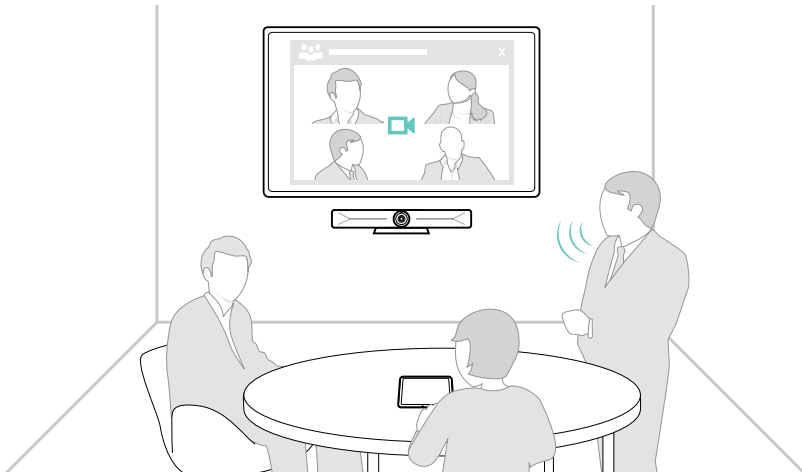

For safety instructions, consult the Safety Guide.



For specifications, consult the Fact sheet available at eposaudio.com

Trademarks

The Bluetooth® word mark and logos are registered trademarks owned by Bluetooth SIG, Inc. and any use of such marks by DSEA A/S is under license.

USB Type-C® and USB-C® are trademarks of USB Implementers Forum.

Kensington is a registered trademark of ACCO Brands. Kensington The Professionals' Choice is a trademark of ACCO Brands. All other trademarks are the property of their respective owners.

Package contents

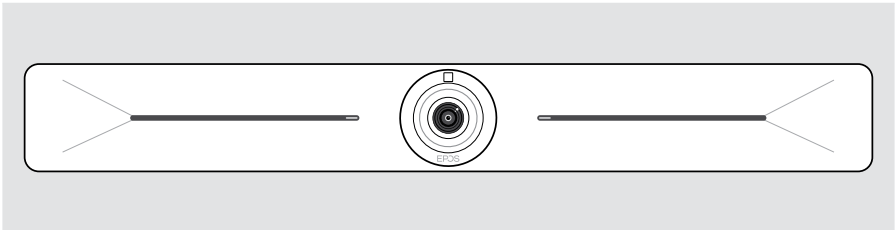

EXPAND Vision 5 Video collaboration bar

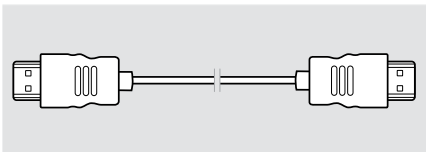

HDMI cable

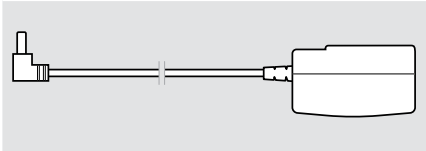

Power supply unit

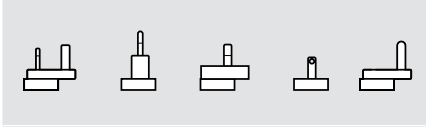

Country adapters
UK, EU, AU, US, IN

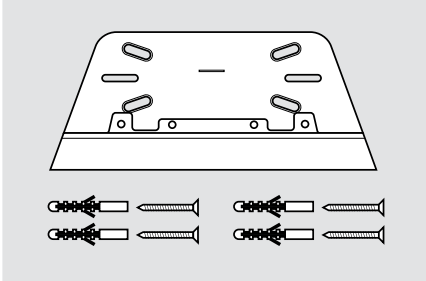

Wall mount accessories

Mounting plate
Dowels*
Dowel screws

*differing wall types may require specific dowels





Quick Guide
Safety Guide
Compliance sheet

Vision 5 at a glance

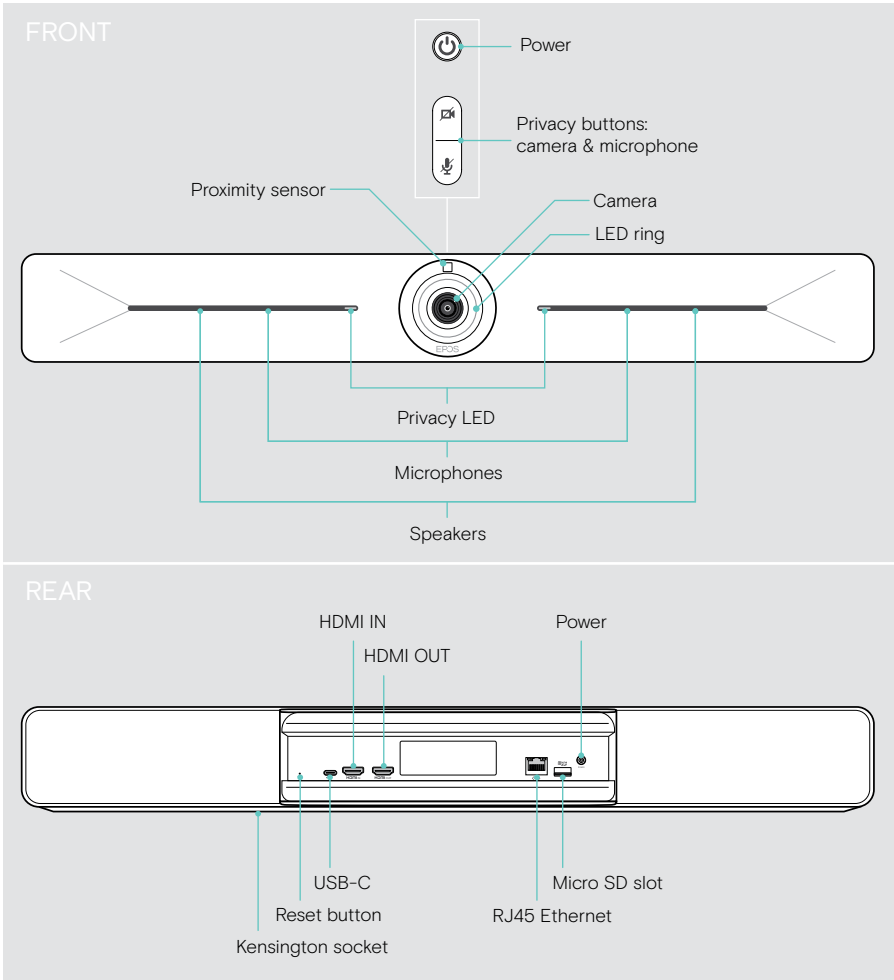















Video collaboration bar at a glance

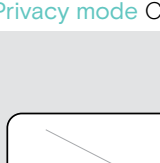

LEDs at a glance

	Switched on		Standby mode
	Switched off / not connected to the mains		

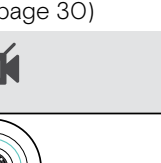
During a meeting

		Camera active			Camera inactive
		Microphone unmuted			Microphone unmuted
		Camera active			Camera inactive
		Microphone muted			Microphone muted

Privacy mode Camera / Microphone (see page 30)

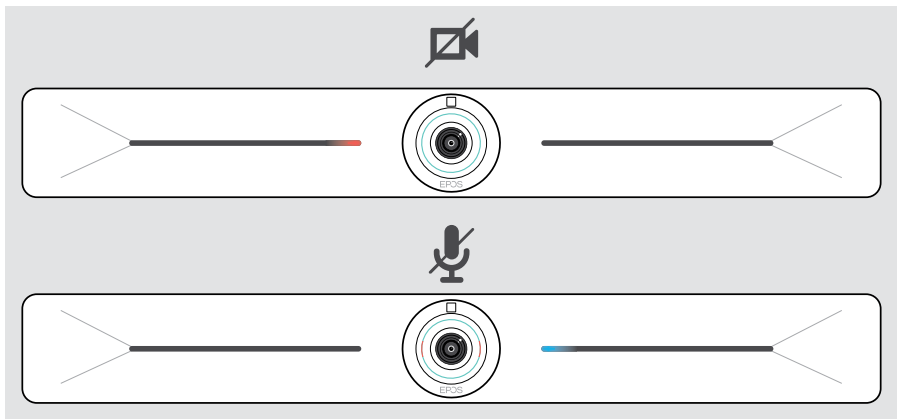

Placing / mounting Vision 5

Installation options

The collaboration bar can be:

- **A** mounted on a wall
- **B** placed on a desk (optional accessory: table stand)

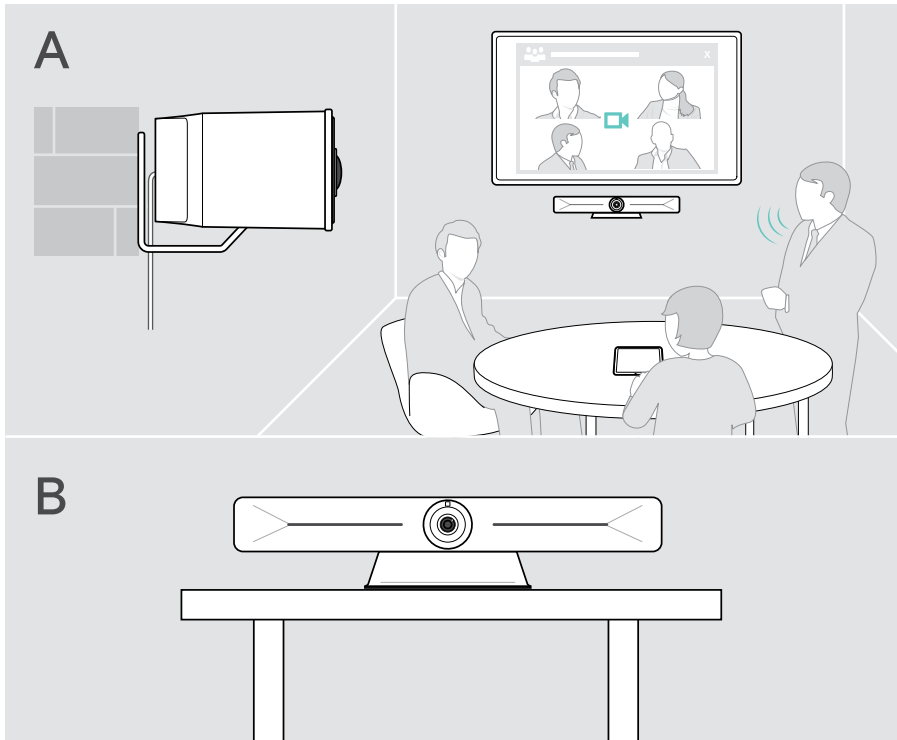

A Mounting the product on a wall



CAUTION

Danger of accidents or damages!

Drilling into e.g. cables and can lead to accidents.

> Check whether there are any cables or pipes in the wall.

The wall type is an example - other wall types may require different mounting.

- 1 Choose a position so that the **camera meets the eye-height of meeting participants**. Hold the mounting plate against the wall, balance it and add two marks.
- 2 Drill two or four holes.
- 3 Insert the dowels.
- 4 Hold the mounting plate against the wall and fix it with the screws. Start on the left and bring it in balance with the other screw.
- 5 Hold the collaboration bar and connect the required cables as the space is small when finally mounted > see page 9.
- 6 Position the collaboration bar and tighten the screws.

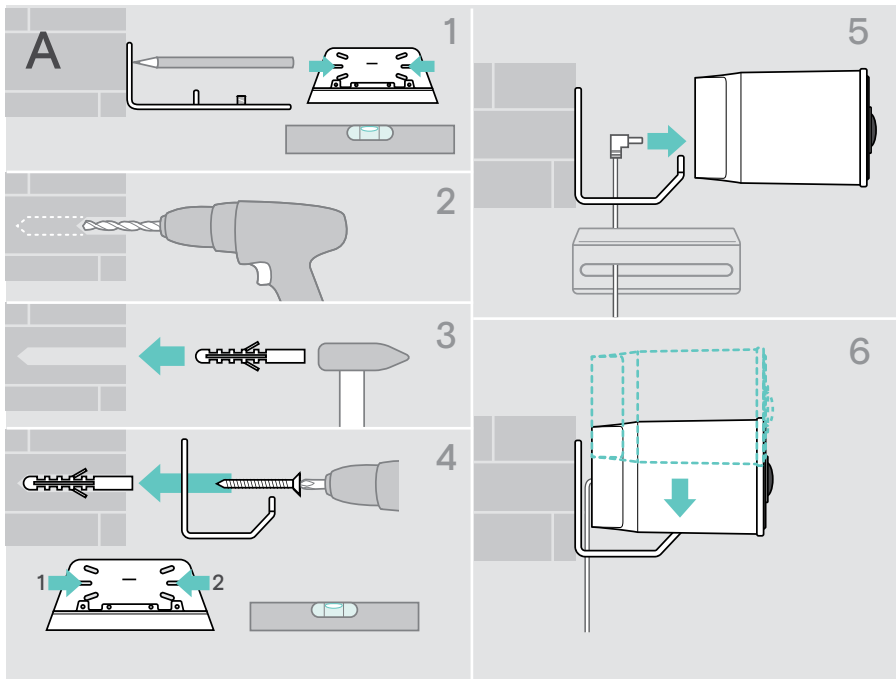

B Placing the product on a desk

- > Click in the table stand (optional accessory: Vision 5 - TTM 01).
- > Place the collaboration bar on your desk.
- > Hold down the stand and rotate the collaboration bar so that it points in the direction of the meeting participants.

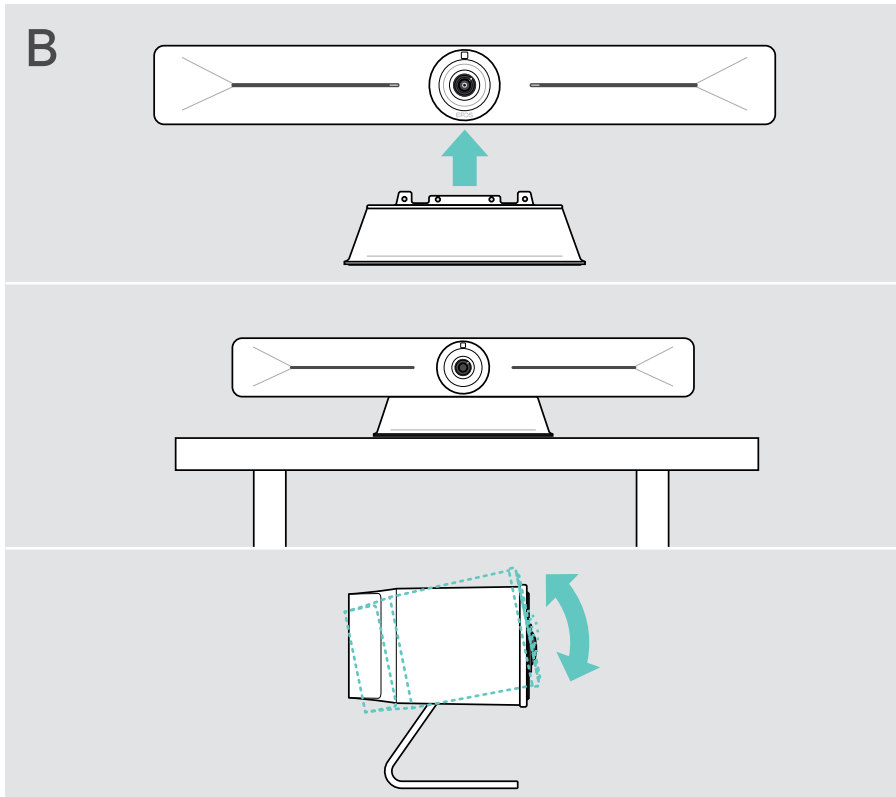

Connecting / preparing devices

Taking off / Putting on the cover

CAUTION

Danger of kinking the cables!

- > Always reattach the cover as it provides strain relief for the connected cables.
- > Turn the screw counterclockwise by 90° to unlock the cover and take it off.

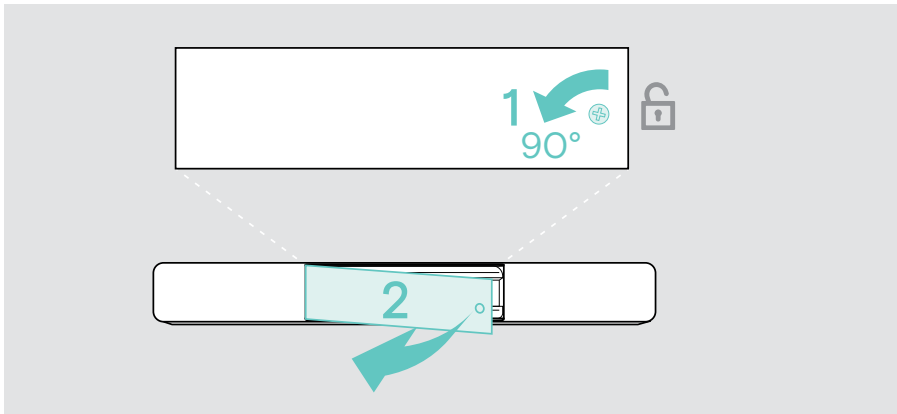

After you have connected your devices:

- > Put the cover on and turn the screw clockwise to lock it.

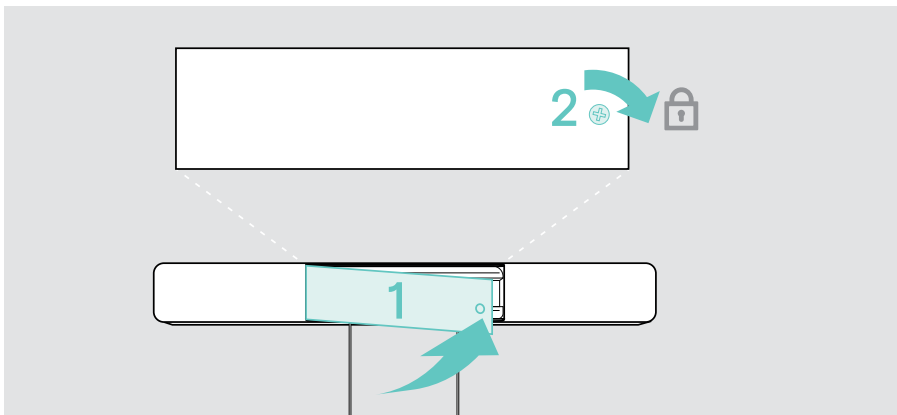

Connection possibilities

The collaboration bar works as an All-in-one solution. You only need a screen, internet access and a UC solution.

Required connections & actions

Page

1	Screen	12
2	Network	13
3	Power supply	14
4	Pair EXPAND Control or a remote control Alternatively you can use the product as a USB device, e.g. if your UC provider is not supported on the EXPAND Vision 5 (see page 17).	15

In addition to the listed devices you can connect a variety of different in- and output devices to the collaboration bar via the ports shown below.

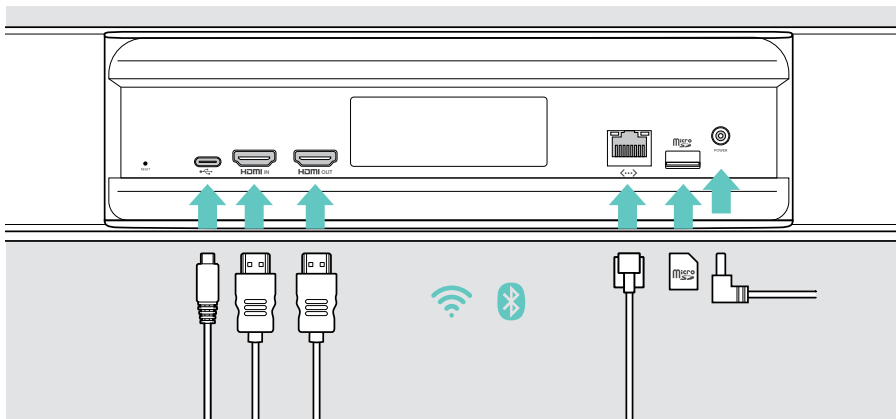



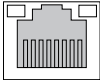

Network options

Page

	Wi-Fi	13
 <...>	Ethernet	

Wired devices & memory card options

Page

	USB-C:	18
	• Audio Device	
	• Keyboard / Mouse	
	• Screen: use it as USB device	
	• Laptop: use it as USB device	17
	HDMI In:	18
	• Laptop: use it for content sharing	
	HDMI Out:	12
	• Screen	
	Micro SD:	18
	• Micro SD memory card: expansion of internal storage	

1 Connecting a screen

You can connect one or two screens via:



HDMI OUT: primary screen/Touch Screen interface

- > Connect the delivered HDMI cable to the **HDMI OUT** and your screen.



USB-C: secondary screen/Touch Screen interface

- > Connect a USB-C cable to the USB-C socket and your screen.

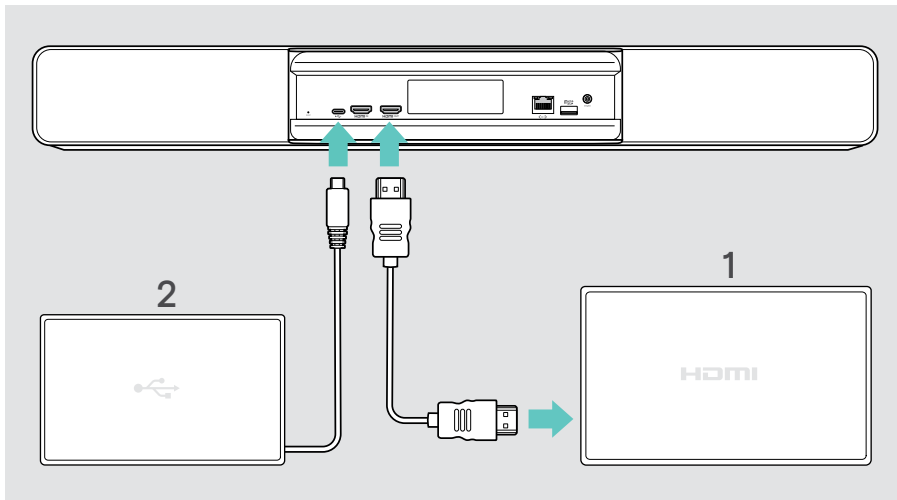

2 Connecting to a network

The collaboration bar requires internet access. You can connect it to a network via:



Wi-Fi:

- > Connect to your Wi-Fi.

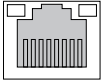

Ethernet:

- > Connect a LAN cable to the Ethernet port.

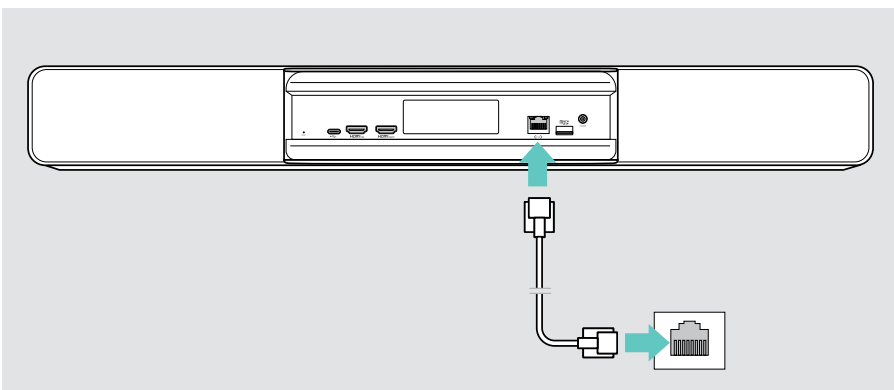

Connecting to Wi-Fi

After the collaboration bar and your screen are turned on:

- > Enter the **Settings** menu > **Device Settings** > **Wi-Fi** to configure your Wi-Fi connection. The Admin settings are password protected.

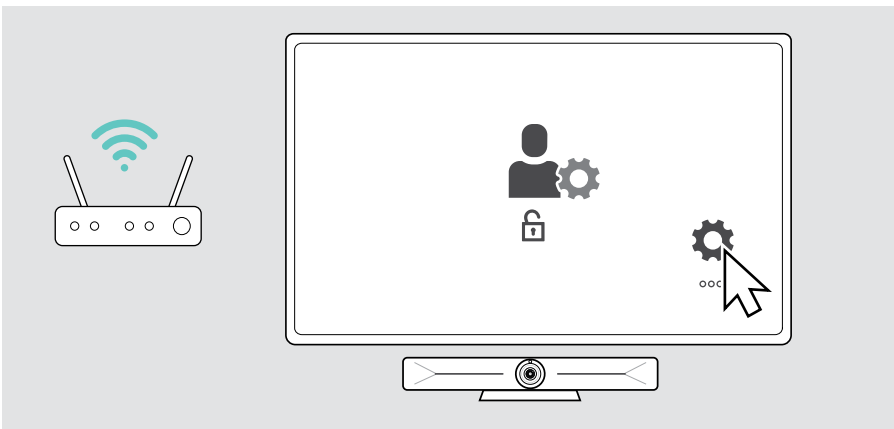

3 Connecting to the power supply



- > Select a suitable country adapter and slide it in.
- > Connect the power supply unit with the **Power** and wall socket. The collaboration bar turns on. The LED ring lights up mint.

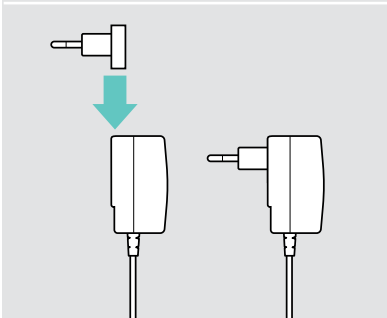
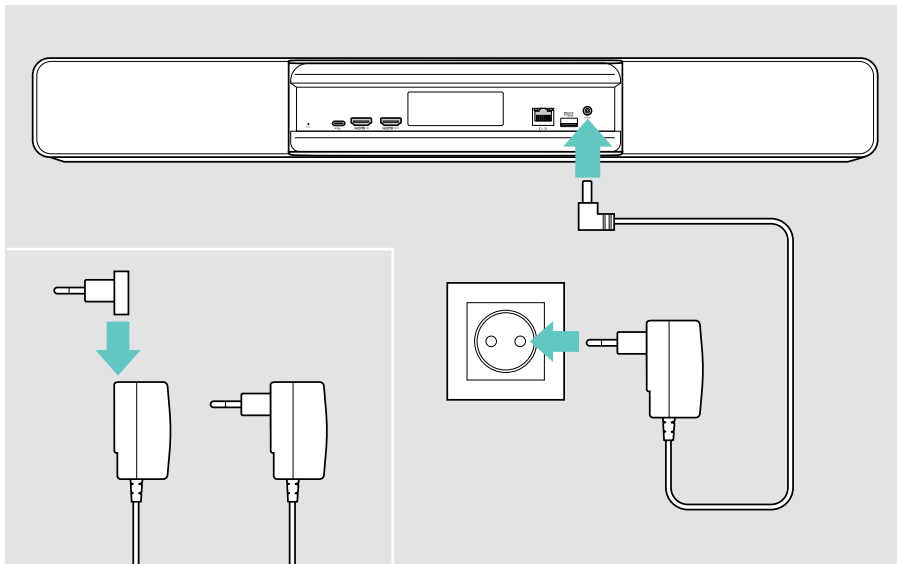

4 Connecting a control

If you do not use a touchscreen, you need a control e.g. the EPOS EXPAND Control with a touch screen or the remote control VISION-RC 01T.

Connecting the EXPAND Control

To establish a connection between EXPAND Control and Vision 5:

- > Follow the steps given in the EXPAND Control User Guide.

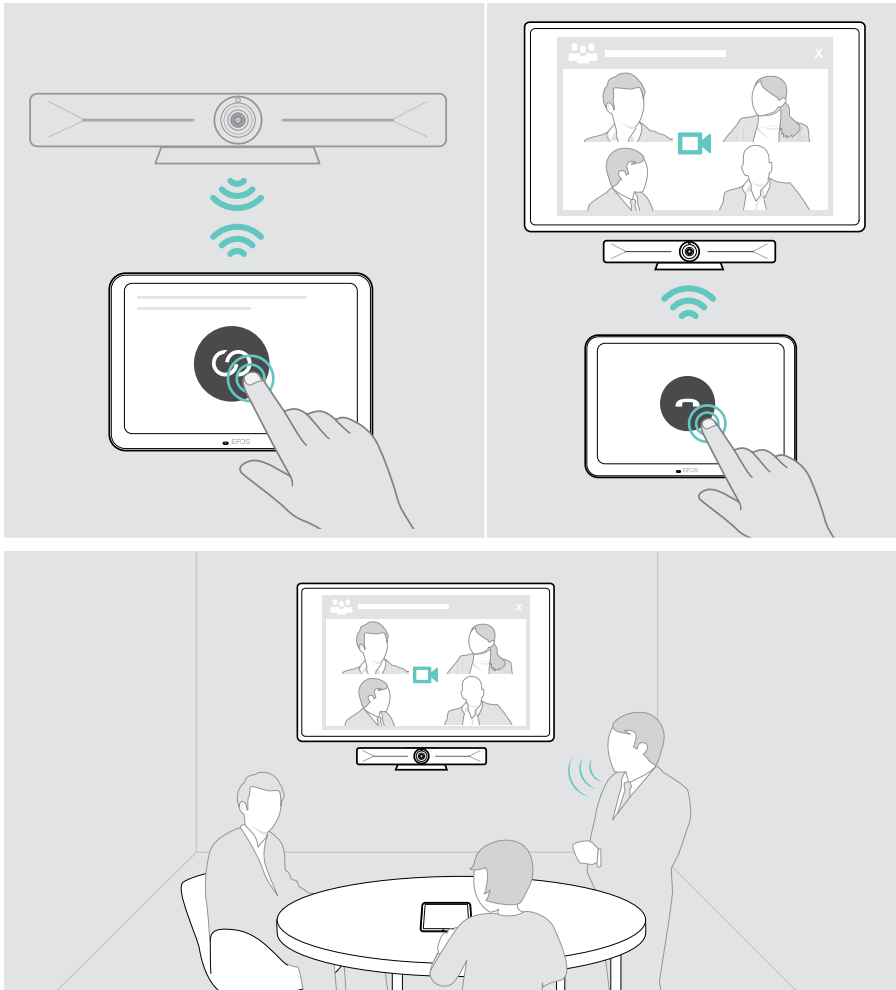

Connecting the VISION-RC 01T remote control – Microsoft Teams only

For Microsoft Teams you could use the comfortable EXPAND Control or the remote control.

- > Unplug and plug in the power supply, to reboot the collaboration bar.
- > Hold the BACK and OK button on the remote control simultaneously until its Pairing LED flashes red continuously.

As soon as the collaboration bar is re-booted the remote will be automatically paired and the remote control's LED turns off.

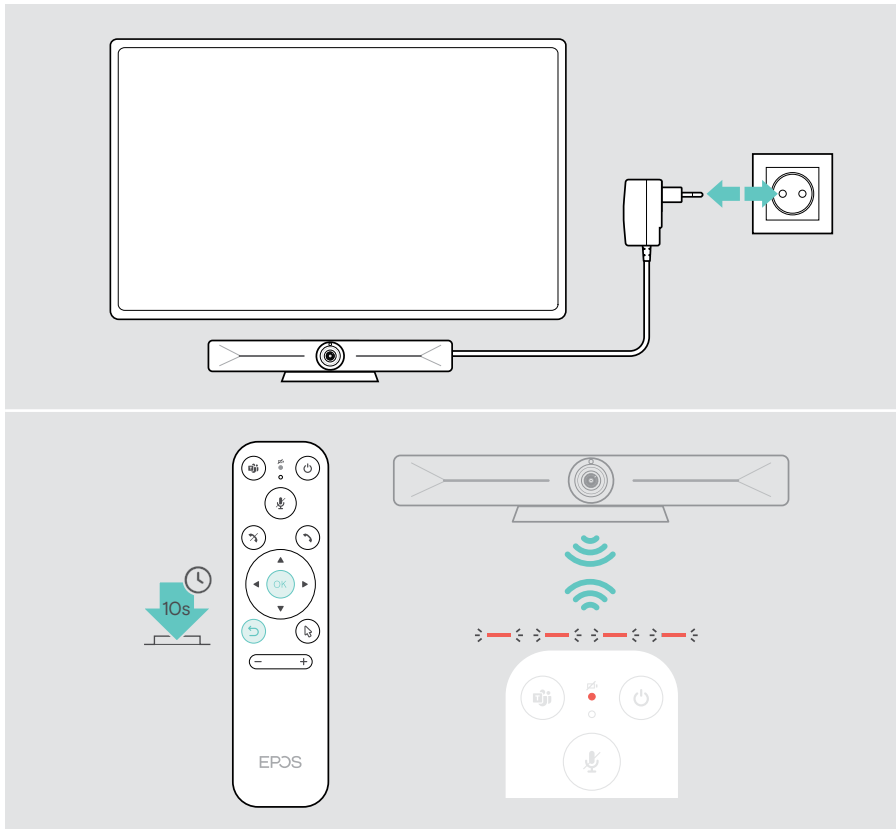

Using EXPAND Vision 5 in USB-mode (BYOD)

If your UC provider is not supported on the EXPAND Vision 5:

- > Use your laptop and the EXPAND Vision 5 as a USB device for meetings instead.
- > Manage the meeting via your laptop instead of the EXPAND Control or remote control.



USB-C:

- > Connect a USB cable from the laptop to the USB-C socket of the EXPAND Vision 5.



HDMI IN:

- > Connect a HDMI cable from the laptop to the **HDMI IN** socket of the EXPAND Vision 5.

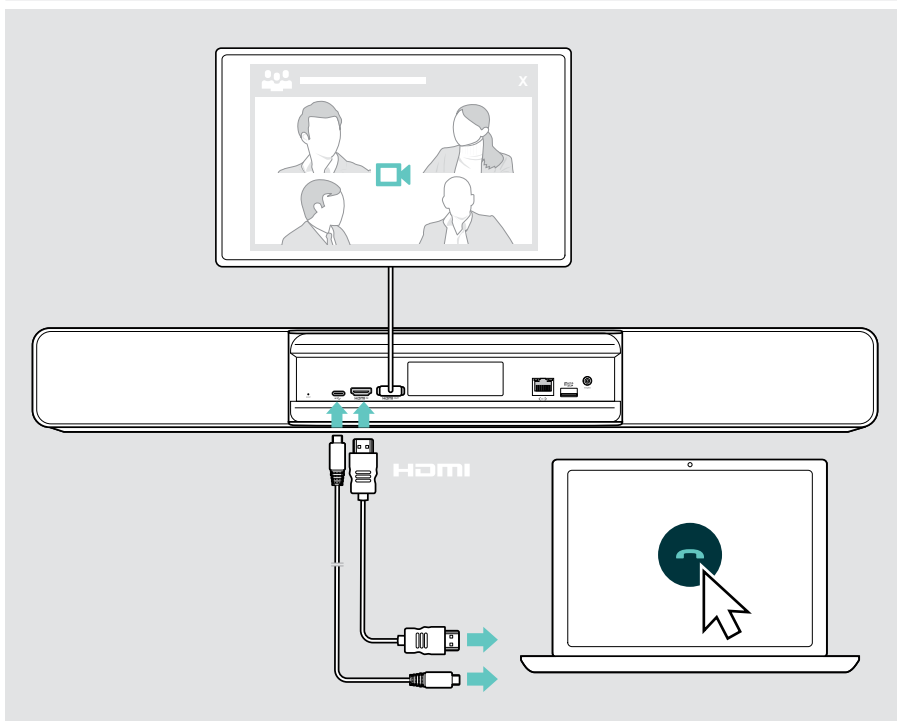

Connecting a laptop for content sharing



HDMI IN:

> Connect a HDMI cable to the **HDMI IN** and your laptop.



USB-C:

> Connect a USB-C cable to the USB-C socket and your laptop.

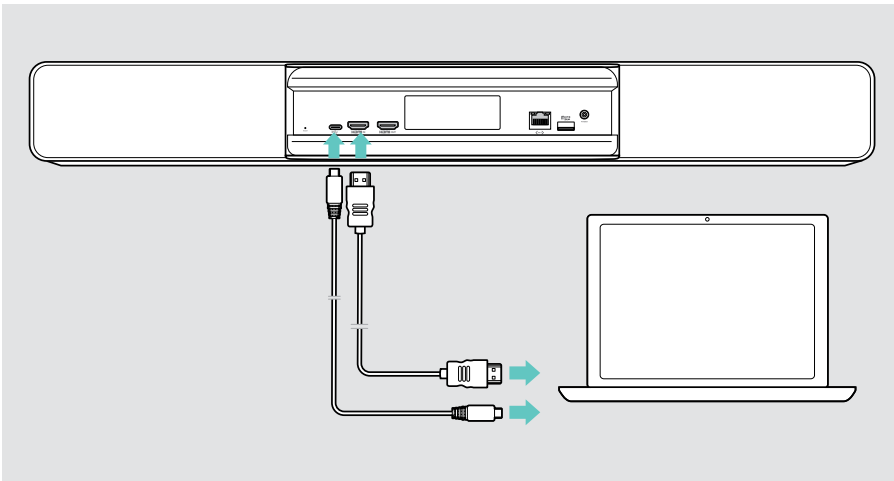

For how to share content: see page 25.

Connecting other accessories

You can connect several other accessories, e.g. for navigation.

USB-C:



- > Connect your wired USB device (keyboard, mouse, touch screen interface). For USB-A devices use e.g. EPOS USB-A to USB-C® Adapter.

Micro SD:



- > Insert a micro SD card for internal storage expansion.

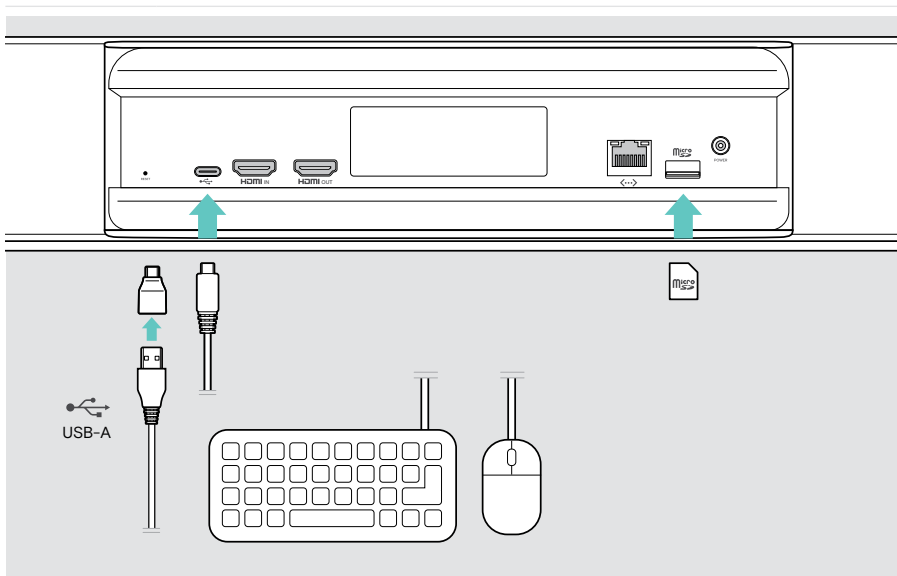

How to use – the basics



The **collaboration bar** turns on automatically as soon as it is connected to power. The LED lights up mint.

If it lights up light red, the device is in standby mode (see page 20).

Adjusting the camera

The camera lens is movable and can be adjusted via the settings menu (see next page).

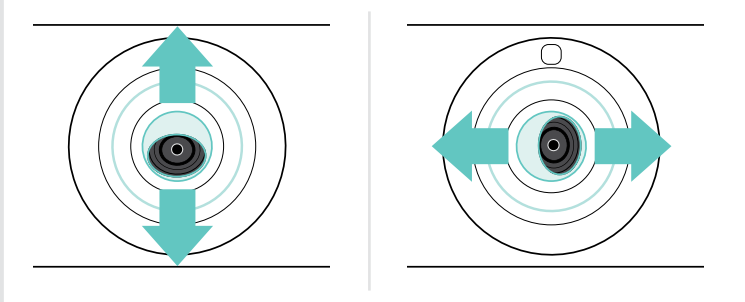
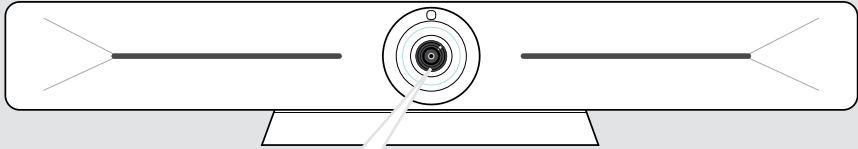

Using the Camera Pan-Tilt-Zoom (PTZ) feature

You can adjust the camera position and digital zoom level to optimally capture the meeting space.

> Enter the [Settings](#) menu > [Device Settings](#) > [Camera controls](#) to adjust it.

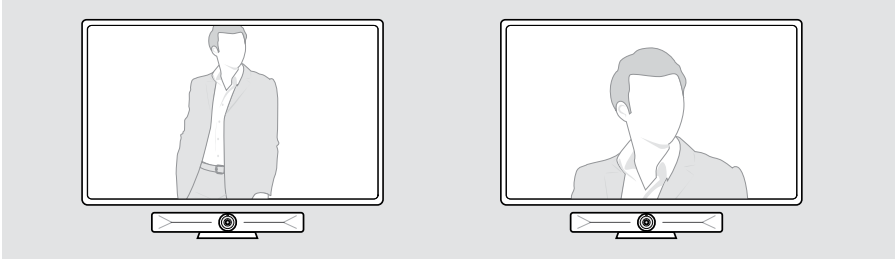

Activating the Intelligent Framing feature

The collaboration bar is equipped with an intelligent framing feature - powered by EPOS AI™. This feature automatically frames the picture and adjusts the digital zoom to effectively capture the meeting participants. The Intelligent Framing keeps participant faces in the center. The function is deactivated by default.

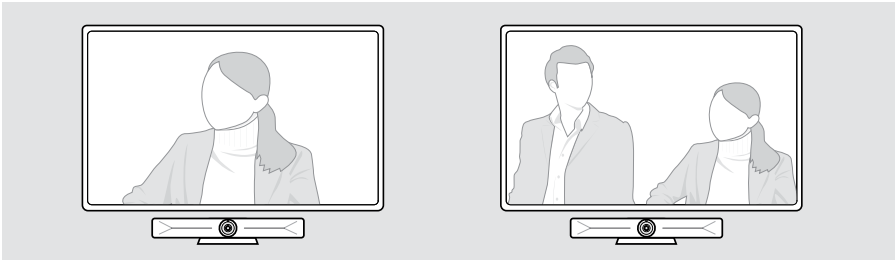

You can activate the Intelligent Framing feature **before** or **during** a meeting.

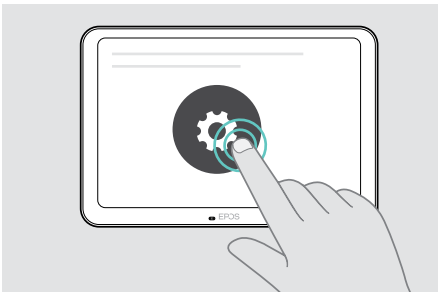

To activate it **before** a meeting:

- > Touch on [... More](#) > [Settings](#) (EXPAND Control).
- > Activate the Intelligent Framing feature in the [Settings](#) menu: [Device Settings](#) > [Camera controls](#).

To activate it **during a meeting** (EXPAND Control only):

- 1 Touch on the small arrow. The room camera settings window appears.

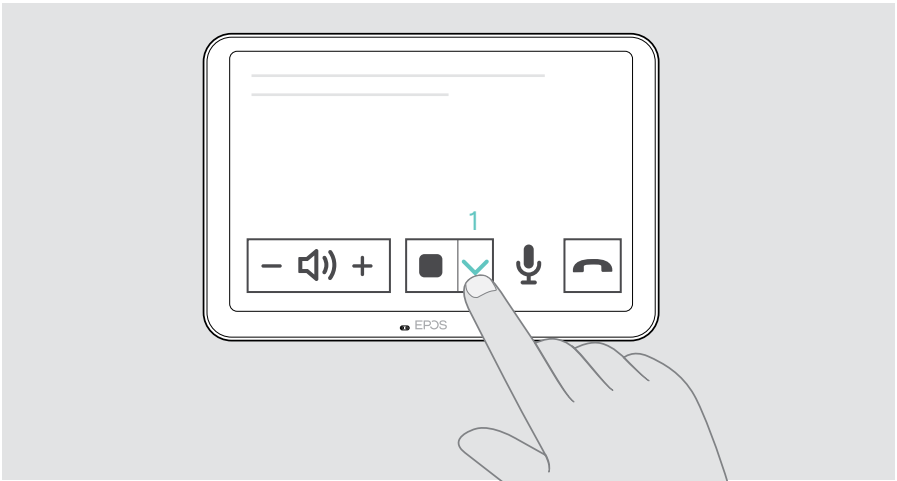

- 2 Activate **Room framing** by moving the slider to the righthand-side.
- 3 Touch on the arrow to close the window.

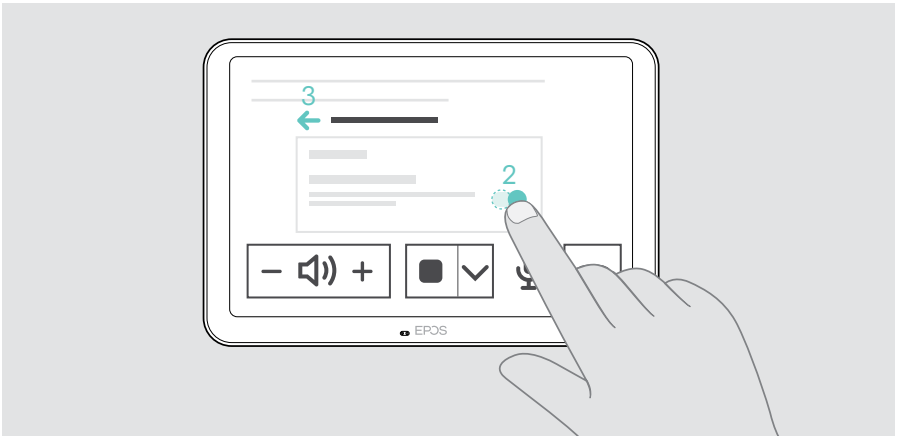

Changing the volume



CAUTION

Risk of hearing damage!

Listening at high volume levels for long periods can lead to permanent hearing defects.

- > Do not continuously expose yourself to high volumes.

- > Adjust the volume in a meeting via the EXPAND Control or remote control.



Muting / unmuting the microphone

- > Mute or unmute the microphone in a meeting via the EXPAND Control or remote control.

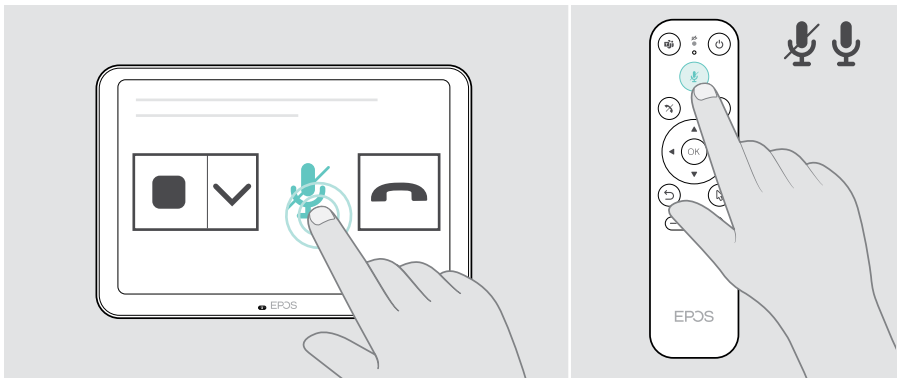

Joining meetings / calls

> Join your video meeting via your EXPAND Control or remote control.

i If you use the product as a USB webcam (laptop connected via USB-C cable), join via the installed UC solution on your laptop.

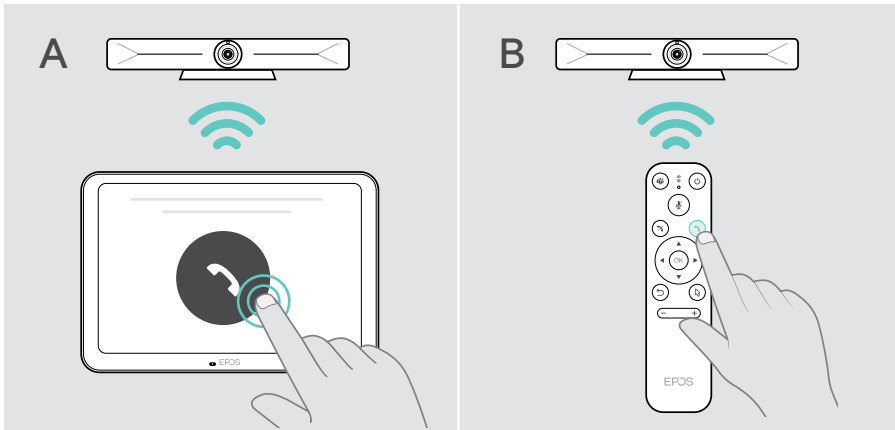

Sharing content in a meeting

You can share your content via your UC provider online (without an additional cable) or via a connected HDMI cable. It is also possible to use Miracast for local content sharing.

Sharing content from your laptop online

While you are in a meeting:

- > Start screen sharing via your UC solution.



Sharing content from your laptop via HDMI / USB-C



HDMI In:

- > Connect a HDMI cable to the **HDMI IN** and your laptop.
- > Start screen sharing via your UC solution.



USB-C:

- > Connect a USB-C cable to the USB-C socket and your laptop.

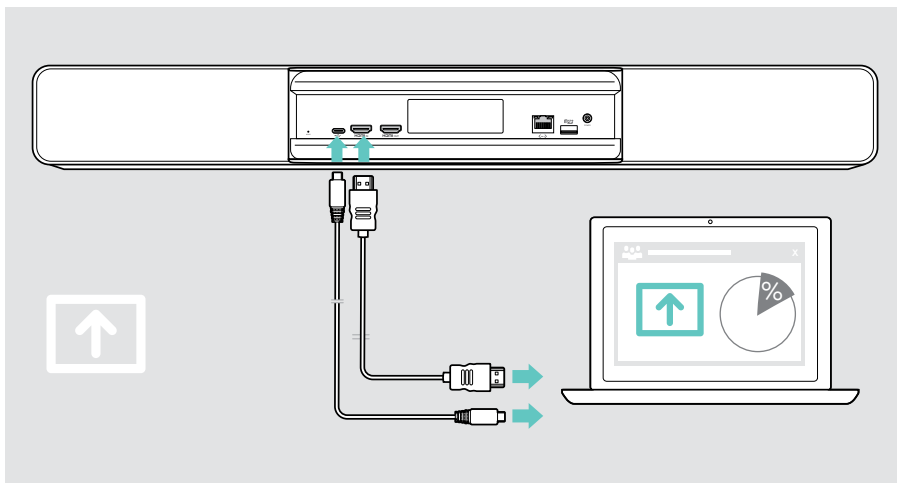

Mirroring the screen

You can use Miracast to display content on the connected screen, e.g. by using the “project” function in Windows.



This function is for local content sharing, not for sharing content in video meetings.

It is possible to change the screencasting name of the device in the settings menu.

Good to know

Using an optional Kensington® lock

You can secure your collaboration bar e.g. on a table of a meeting room with an optional Kensington lock.

- > Follow the instructions for your Kensington lock to fix it at the bottom.

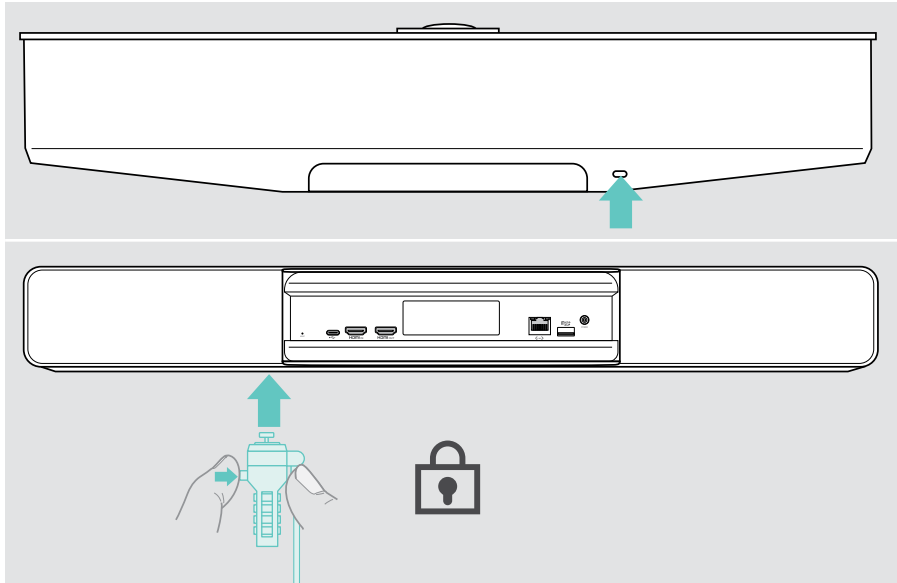

Standby mode & waking up

The collaboration bar turns on automatically as soon as it is connected to power.



The collaboration bar turns to standby mode, if:

- the proximity sensor detects no activity in the meeting room or
- you have activated backlight timer in the settings (see page 31) or
- you press the power button on the top of the collaboration bar or on the connected EXPAND Control / remote control. The LED ring lights up dimmed red.

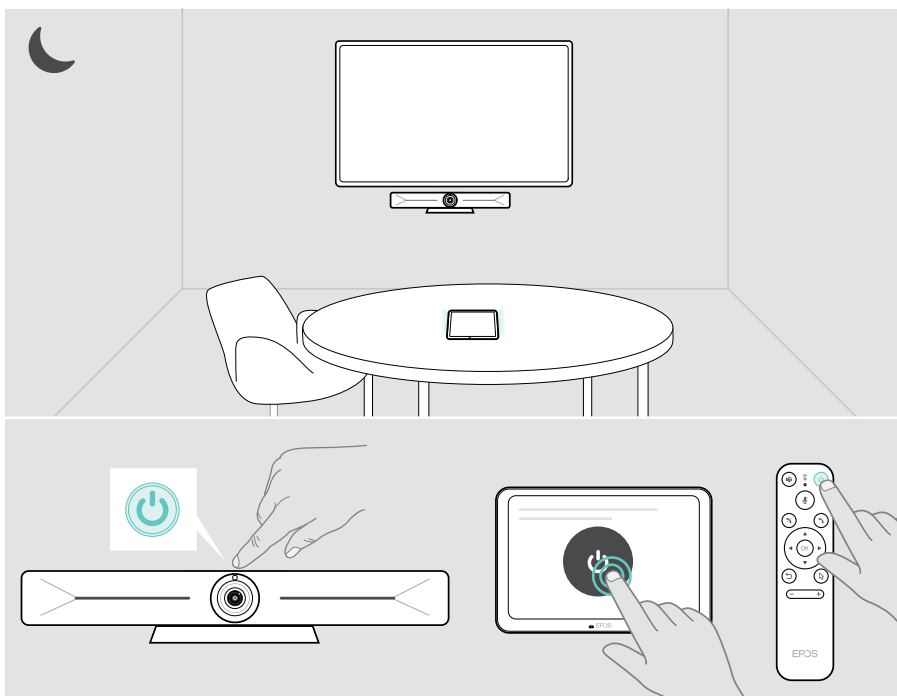



If the proximity sensor recognizes a movement in the room, the collaboration bar and the connected devices wakes up **automatically**.

The LED ring lights up mint.

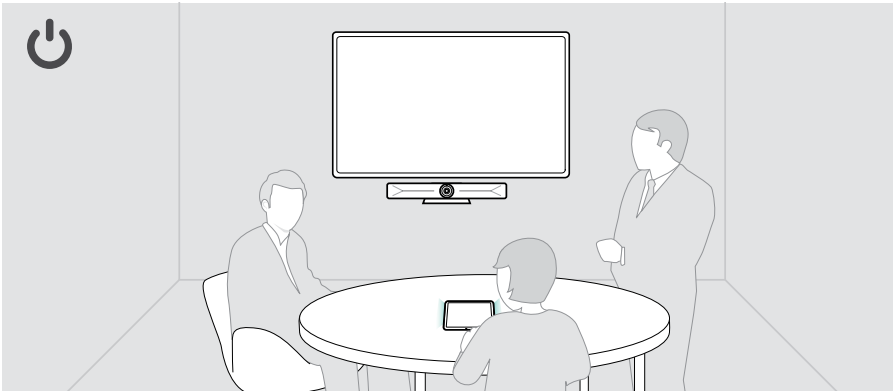

To wake up the collaboration bar **manually**:

- > Press the power button on the connected EXPAND Control / remote control.



Using the privacy buttons

For additional privacy, the collaboration bar is equipped with hardwired switches for disabling the camera and/or microphones.

- > Press the button on the collaboration bar to activate / deactivate the camera or microphones.

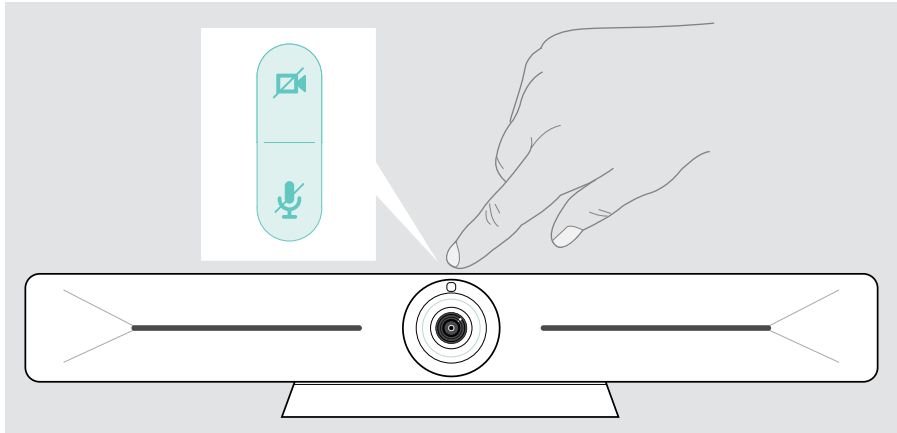

Camera deactivated:
Privacy mode



Microphones deactivated:
Privacy mode

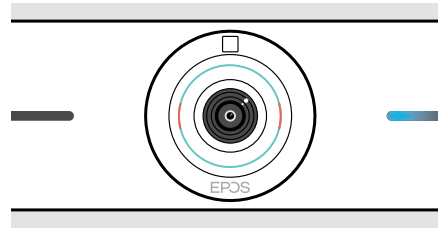
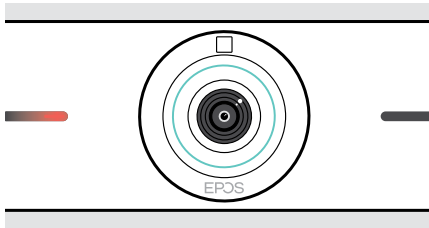

If the privacy mode is activated, the only way to enable it is via the privacy switches.

The switches are intended for additional privacy and not to be used during video meetings.

Changing Vision 5 settings

The on screen settings menu is used for e.g. setting up, configuring and personalizing the device – for example:

- Network and wireless devices connections
- Camera controls
- Display settings
- Language

 The Admin settings are password protected.

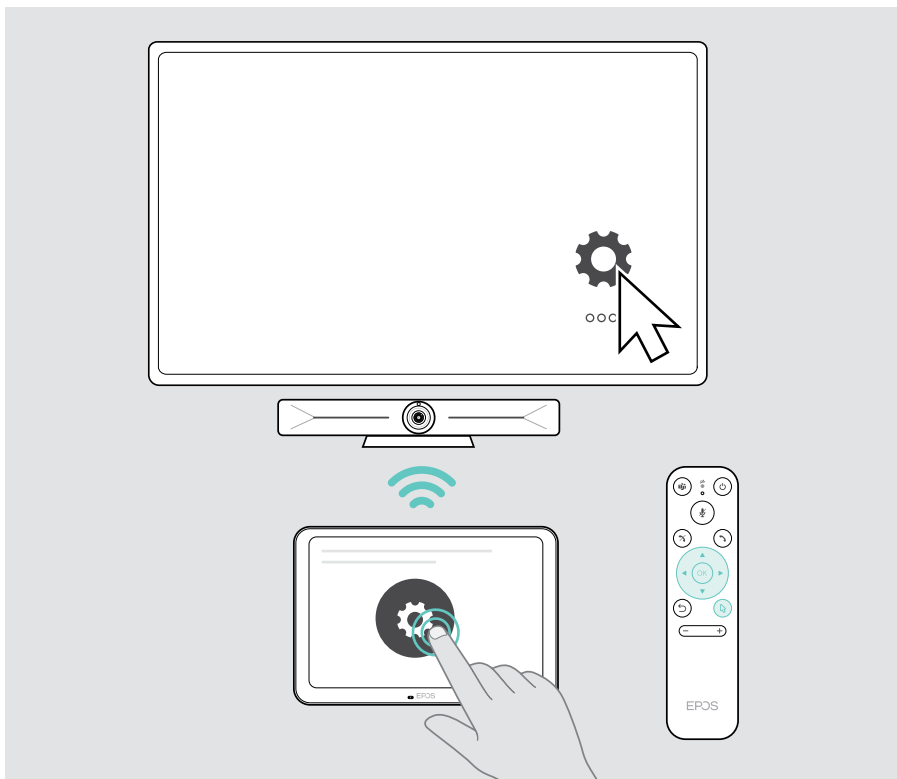

Maintaining & updating products

Cleaning the products

CAUTION

Liquids can damage the electronics of the product!

Liquids entering the housing of the device can cause a short circuit and damage the electronics.

- > Keep all liquids far away from the product.
 - > Do not use any cleansing agents or solvents.
-
- > Use a dry cloth to clean the product only.
 - > Use a damp cloth to clean the lens.

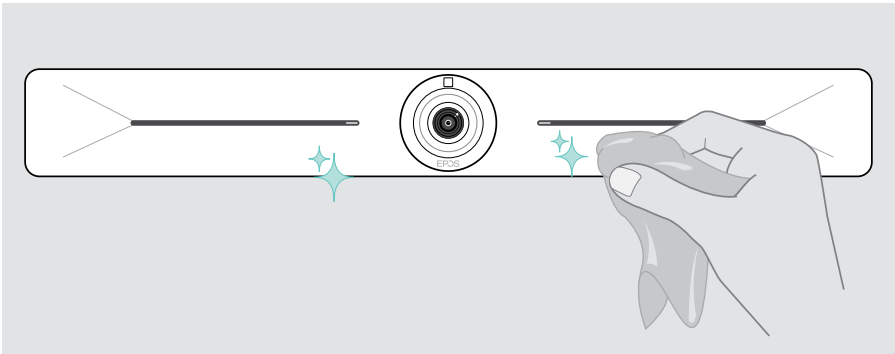

Updating the firmware

Updates for the EXPAND Vision 5 will be made available through your UC solution and will be downloaded and installed automatically – once enabled by the IT-administrator.

If a problem occurs...

Problem	Possible cause	Solution	Page
Conference call can not be established	Firewall is blocking the call	> Check and change the network firewall settings.	-
Camera image not displayed correctly	Camera position not optimal	> Change the camera positioning and zoom level.	20
Mouse pointer not visible on screen	Mouse pointer disappears after a while	> Press the remote control's arrow button.	-
No audio	Connector not inserted correctly	> Check the cable connection.	9
	Privacy mode for microphone active: collaboration bar front LEDs blue	> Press the mute button on top of the collaboration bar.	30
Low video quality	Poor internet connection	> Check your internet connection performance.	-
	Plastic protection on camera lense not removed	> Remove the plastic protection.	-
No picture on connected screen or no video captured	Wrong input source selected on connected screen	> Change input on the screen.	9
	Cable not connected properly	> Check the cable connection.	9
	Privacy mode for camera active: collaboration bar front LEDs red	> Press the camera button on top of the collaboration bar.	30
UC solution does not run	UC solution is not supported by the EPOS EXPAND Vision 5	> Connect your laptop via USB-C cable to use the product as a USB device.	17
Collaboration bar does not respond	Collaboration bar has experienced an unexpected error	1 Unplug and plug-in the power supply unit to reboot.	-
		2 Reset the collaboration bar.	34

If a problem occurs that is not listed here or if the problem cannot be solved with the proposed solutions, please contact your local EPOS partner for assistance.

To find an EPOS partner in your country, search at [eposaudio.com](https://www.eposaudio.com).

Restoring factory default settings (hard reset)

- > Unplug the Power supply at the **Power** socket.
- > Press and hold the reset button with e.g. a paper clip.
- > Plug-in the Power supply again.
- > Keep holding the reset button for 10 seconds.
- > Release the reset button.

The collaboration bar factory default settings are restored. The LED lights up and the wizard appears on the screen.

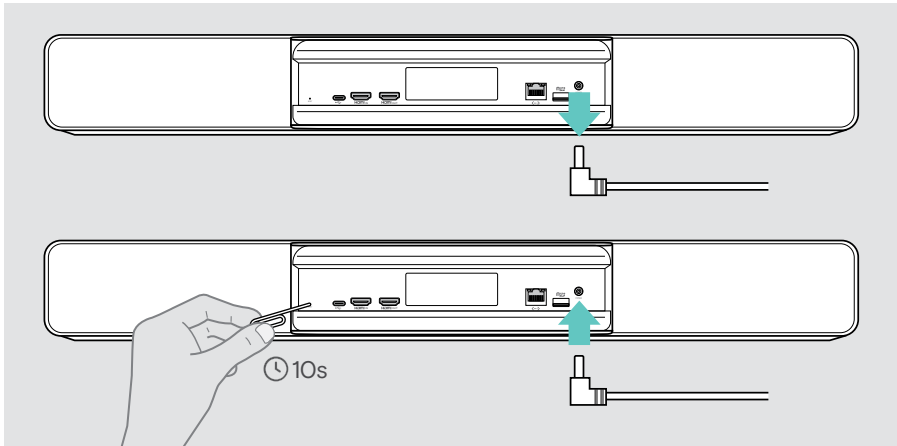

If you release the reset button before the 10 seconds, the developer menu appears on the screen. Repeat the steps above to reset the device.

EPOS

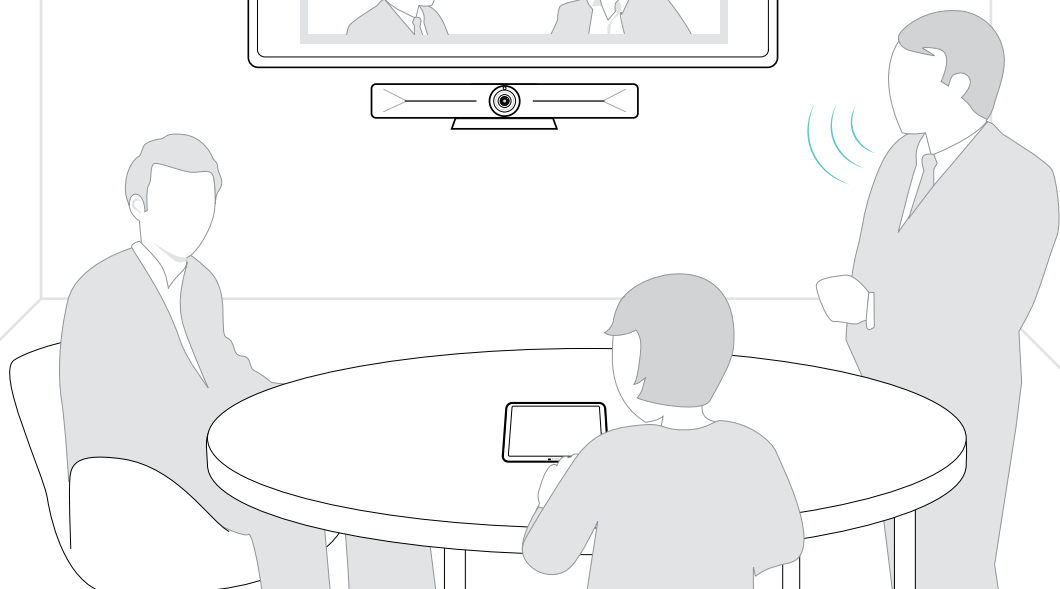

DSEA A/S

Kongebakken 9, DK-2765 Smørum, Denmark
eposaudio.com

Publ. 08/23, A05